

Part No. 060453-10 Rev. A
January 2017

OmniSwitch AOS Release 8 Transceivers Guide

8.3.1.R02

Alcatel·Lucent 
Enterprise

enterprise.alcatel-lucent.com

This user guide contains transceiver specifications and compatibility information for the OmniSwitch AOS Release 8 and supported platforms. The information described in this guide is subject to change without notice.

Attention: Use of any transceivers other than those part numbers listed in the Compatibility Matrices is prohibited. Failure to comply with these matrices is not guaranteed for proper performance and may result in voiding the warranty for the affected platforms.

enterprise.alcatel-lucent.com Alcatel-Lucent and the Alcatel-Lucent Enterprise logo are trademarks of Alcatel-Lucent. To view other trademarks used by affiliated companies of ALE Holding, visit: enterprise.alcatel-lucent.com/trademarks. All other trademarks are the property of their respective owners. The information presented is subject to change without notice. Neither ALE Holding nor any of its affiliates assumes any responsibility for inaccuracies contained herein. (2017)



Service & Support Contact Information

North America: 800-995-2696

Latin America: 877-919-9526

EMEA: +800 00200100 (Toll Free) or +1(650)385-2193

Asia Pacific: +65 6240 8484

Web: support.esd.alcatel-lucent.com

Email: ebg_global_supportcenter@al-enterprise.com

Contents

	About This Guide	v
	Supported Platforms	v
	Who Should Read this Manual?	vi
	When Should I Read this Manual?	vi
	What is Not in this Manual?	vi
	How is the Information Organized?	vi
	Documentation Roadmap	vii
	Related Documentation	ix
	Technical Support	x
Chapter 1	Small Form-Factor Pluggables (SFP/SFP+/QSFP+)	1-1
	In This Chapter	1-1
	SFP MSA Specification	1-2
	Transceiver Installation and Removal	1-3
	40-Gigabit Fiber Optic Cables	1-6
	QSFP to QSFP 40G Fiber Optic Cable	1-6
	QSFP to SFP+ Splitter Fiber Optic Cable	1-6
	Gigabit Ethernet Transceivers	1-7
	Dual Speed Ethernet Transceivers	1-13
	100 FX Ethernet Transceivers	1-15
	10-Gigabit SFP+ Transceivers	1-19
	40-Gigabit QSFP+ Transceivers	1-23
	Fibre Channel Transceivers	1-27
	Industrial Transceivers	1-28
Chapter 2	Transceiver Compatibility Matrix	1-33
	In This Chapter	1-33
	OmniSwitch 10K Compatibility	1-34
	OmniSwitch 6900 Compatibility	1-36
	OmniSwitch 6860 Compatibility	1-38
	OmniSwitch 6865 Compatibility	1-40
	OmniSwitch 9900 Compatibility	1-41

About This Guide

This *OmniSwitch AOS Release 8 Transceivers Guide* provides specifications and compatibility information for the supported OmniSwitch transceivers for all OmniSwitch AOS Release 8 products.

Supported Platforms

This information in this guide applies to the following products:

- OmniSwitch 10K
- OmniSwitch 6900
- OmniSwitch 6860(E)
- OmniSwitch 6865
- OmniSwitch 9900

Unsupported Platforms

The information in this guide does not apply to the following products:

- All other platforms

Who Should Read this Manual?

The audience for this user guide is network administrators and IT support personnel who need to provide network connectivity using SFP, SFP+, and QSFP+ transceivers.

When Should I Read this Manual?

Read this guide as soon as you are ready to integrate your OmniSwitch into your network and you are ready to provide connectivity using the supported transceivers. You should have already stepped through the first login procedures and read the brief software overviews in the appropriate *OmniSwitch Hardware Guide*.

This guide includes information about the supported OmniSwitch transceivers.

- SFP/SFP+/QSFP+ specifications
- SFP/SFP+/QSFP+ compatibility information

What is Not in this Manual?

Procedures for switch management methods, such as CLI, web-based (WebView or OmniVista) or SNMP, are outside the scope of this guide.

For information on WebView and SNMP switch management methods consult the *OmniSwitch Switch Management Guide*. Information on using WebView and OmniVista can be found in the context-sensitive on-line help available with those network management applications.

This guide is designed to provide transceiver specification and compatibility information only and is not intended as a reference for any CLI commands or configuration information. Refer to the Documentation Roadmap for a list of available user guides.

How is the Information Organized?

Chapters in this guide are broken down by transceiver type.

Specification Information. Each transceiver has an associated table providing individual specifications for all supported transceivers.

Compatibility Information. A compatibility chart is provided for each transceiver specifying which modules or switch the transceiver is supported on.

Documentation Roadmap

The OmniSwitch user documentation suite was designed to supply you with information at several critical junctures of the configuration process. The following section outlines a roadmap of the manuals that will help you at each stage of the configuration process. Under each stage, we point you to the manual or manuals that will be most helpful to you.

Stage 1: Using the Switch for the First Time

Pertinent Documentation: *OmniSwitch Hardware Users Guide*
Release Notes

This guide provides all the information you need to get your switch up and running the first time. It provides information on unpacking the switch, rack mounting the switch, installing NI modules, unlocking access control, setting the switch's IP address, and setting up a password. It also includes succinct overview information on fundamental aspects of the switch, such as hardware LEDs, the software directory structure, CLI conventions, and web-based management.

At this time you should also familiarize yourself with the Release Notes that accompanied your switch. This document includes important information on feature limitations that are not included in other user guides.

Stage 2: Gaining Familiarity with Basic Switch Functions

Pertinent Documentation: *OmniSwitch Hardware Users Guide*
OmniSwitch AOS Release 8 Switch Management Guide

Once you have your switch up and running, you will want to begin investigating basic aspects of its hardware and software. Information about switch hardware is provided in the *OmniSwitch 10K Hardware Guide*. This guide provides specifications, illustrations, and descriptions of all hardware components, such as chassis, power supplies, Chassis Management Modules (CMMs), Network Interface (NI) modules, and cooling fans. It also includes steps for common procedures, such as removing and installing switch components.

This guide is the primary users guide for the basic software features on a single switch. This guide contains information on the switch directory structure, basic file and directory utilities, switch access security, SNMP, and web-based management. It is recommended that you read this guide before connecting your switch to the network.

Stage 3: Integrating the Switch Into a Network

Pertinent Documentation: *OmniSwitch AOS Release 8 Network Configuration Guide*
OmniSwitch AOS Release 8 Advanced Routing Configuration Guide
OmniSwitch AOS Release 8 Data Center Switching Guide

When you are ready to connect your switch to the network, you will need to learn how the OmniSwitch implements fundamental software features, such as 802.1Q, VLANs, Spanning Tree, and network routing protocols. The *Network Configuration Guide* contains overview information, procedures, and examples on how standard networking technologies are configured on the OmniSwitch.

The *Advanced Routing Guide* includes configuration information for networks using advanced routing technologies (OSPF and BGP) and multicast routing protocols (DVMRP and PIM-SM).

The *Data Center Switching Guide* includes configuration information for data center networks using virtualization technologies (SPBM and UNP) and Data Center Bridging protocols (PFC, ETC, and DCBX).

Anytime

The *OmniSwitch AOS Release 8 CLI Reference Guide* contains comprehensive information on all CLI commands supported by the switch. This guide includes syntax, default, usage, example, related CLI command, and CLI-to-MIB variable mapping information for all CLI commands supported by the switch. This guide can be consulted anytime during the configuration process to find detailed and specific information on each CLI command.

Related Documentation

The following are the titles and descriptions of all the OmniSwitch user manuals:

- *OmniSwitch 10K/9900/6900/6860/6865 Hardware Users Guides*

Describes the hardware and software procedures for getting an OmniSwitch up and running as well as complete technical specifications and procedures for all OmniSwitch chassis, power supplies, fans, and Network Interface (NI) modules.
- *OmniSwitch AOS Release 8 CLI Reference Guide*

Complete reference to all CLI commands supported on the OmniSwitch. Includes syntax definitions, default values, examples, usage guidelines and CLI-to-MIB variable mappings.
- *OmniSwitch AOS Release 8 Switch Management Guide*

Includes procedures for readying an individual switch for integration into a network. Topics include the software directory architecture, image rollback protections, authenticated switch access, managing switch files, system configuration, using SNMP, and using web management software (WebView).
- *OmniSwitch AOS Release 8 Network Configuration Guide*

Includes network configuration procedures and descriptive information on all the major software features and protocols included in the base software package. Chapters cover Layer 2 information (Ethernet and VLAN configuration), Layer 3 information (routing protocols, such as RIP and IPX), security options (authenticated VLANs), Quality of Service (QoS), link aggregation, and server load balancing.
- *OmniSwitch AOS Release 8 Advanced Routing Configuration Guide*

Includes network configuration procedures and descriptive information on all the software features and protocols included in the advanced routing software package. Chapters cover multicast routing (DVMRP and PIM-SM), Open Shortest Path First (OSPF), and Border Gateway Protocol (BGP).
- *OmniSwitch AOS Release 8 Data Center Switching Guide*

Includes an introduction to the OmniSwitch data center switching architecture as well as network configuration procedures and descriptive information on all the software features and protocols that support this architecture. Chapters cover Shortest Path Bridging MAC (SPBM), Data Center Bridging (DCB) protocols, Virtual Network Profile (vNP), and the Edge Virtual Bridging (EVB) protocol.
- *OmniSwitch AOS Release 8 Transceivers Guide*

Includes transceiver specifications and product compatibility information.
- *OmniSwitch AOS Release 8 Specifications Guide*

Includes Specifications table information for the features documented in the Switch Management Guide, Network Configuration Guide, Advanced Routing Guide, and Data Center Switching Guide.
- *Technical Tips, Field Notices*

Includes information published by Alcatel's Customer Support group.
- *Release Notes*

Includes critical Open Problem Reports, feature exceptions, and other important information on the features supported in the current release and any limitations to their support.

Technical Support

An Alcatel-Lucent service agreement brings your company the assurance of 7x24 no-excuses technical support. You'll also receive regular software updates to maintain and maximize your Alcatel-Lucent product's features and functionality and on-site hardware replacement through our global network of highly qualified service delivery partners.

With 24-hour access to Alcatel-Lucent Enterprise Service and Support web page, you'll be able to view and update any case (open or closed) that you have reported to Alcatel-Lucent Enterprise technical support, open a new case or access helpful release notes, technical bulletins, and manuals.

Access additional information on Alcatel-Lucent Enterprise Programs:

Web: support.esd.alcatel-lucent.com

Phone: 1-800-995-2696

Email: ebg_global_supportcenter@al-enterprise.com

1 Small Form-Factor Pluggables (SFP/SFP+/QSFP+)

OmniSwitch Series switches use both copper-based and fiber-based optical Small Form Factor Pluggable transceivers. These transceivers are fully hot-swappable and are available for both short-reach and long-reach applications. Copper-based and fiber-based optical transceivers can be mixed on the same module.

In This Chapter

This chapter describes the technical specifications for all the OmniSwitch supported transceivers. For additional details about OmniSwitch modules, see the appropriate *OmniSwitch Hardware Guide*.

Transceiver specifications in this chapter include:

- SFP MSA Specifications. See [“SFP MSA Specification”](#) on page 1-2.
- Transceiver Installation. See [“Transceiver Installation and Removal”](#) on page 1-3.
- 40-Gigabit Fiber Optic Cable Overview. See [“40-Gigabit Fiber Optic Cables”](#) on page 1-6.
- Gigabit Ethernet Transceivers. See [“Gigabit Ethernet Transceivers”](#) on page 1-7.
- Dual Speed Ethernet Transceivers. See [“Dual Speed Ethernet Transceivers”](#) on page 1-13.
- 100-FX Ethernet Transceivers. See [“100 FX Ethernet Transceivers”](#) on page 1-15.
- 10-Gigabit SFP+ Transceivers. See [“10-Gigabit SFP+ Transceivers”](#) on page 1-19.
- 40-Gigabit QSFP+ Transceivers. See [“40-Gigabit QSFP+ Transceivers”](#) on page 1-24.
- 40-Gigabit QSFP+ Transceivers. See [“Industrial Transceivers”](#) on page 1-29.
- Fibre Channel Transceivers. See [“Fibre Channel Transceivers”](#) on page 1-28.
- For a transceiver compatibility matrix, see [“Transceiver Compatibility Matrix”](#) on page 2-34.

SFP MSA Specification

The Small Form-Factor Pluggable (SFP) MSA (Multi Source Agreement) is a specification for a common interface for optical modular transceivers. The SFP connector consists of a 20-pin receptacle and an SFP housing cage. The connector provides the interface for the hot pluggable SFP module. Each SFP module contains a serial interface to provide identification information that describes the SFP capabilities, stand interfaces, manufacturer and other information.

For information on installing SFPs, refer to the documentation included with the transceiver.

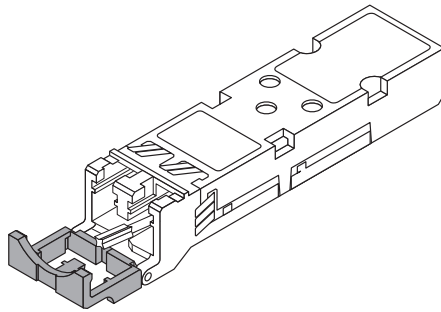

This diagram is a representation only; the physical appearance of the actual module may vary slightly.

Small Form Factor Pluggable (SFP)

Transceiver Installation and Removal

Follow the instructions below for the appropriate transceiver type.

ESD Caution: Before handling the module, you must discharge all static electricity on your person to avoid Electrostatic Discharge (ESD) damage. If using a wrist strap, ensure that the wrist strap touches your skin. Attach the other end of the strap to the chassis. If your chassis provides a grounding lug, this can be used. Refer to your hardware user guide for details.

If using a wrist strap, ensure that the wrist strap touches your skin. Attach the other end of the strap to the chassis. If your chassis provides a grounding lug, this can be used. Refer to your hardware user guide for details.

Dust Exposure: To reduce the risk of dust exposure and physical damage, be sure to replace the protective rubber cover (provided) when the SFP is not in use.

Eye Safety: SFP transceivers are international Class 1 laser products and are eye-safe devices *when operated within the limits of manufacturers' specifications*. Operating SFP transceivers in a manner inconsistent with intended usage and specification may result in hazardous radiation exposure.

Note: After removing a transceiver, wait for a minimum of 5 seconds before re-inserting any transceiver into the same port. This allows sufficient time for software to detect the removal of the transceiver.

Note: *Never force the transceiver in or out of the transceiver slot.*

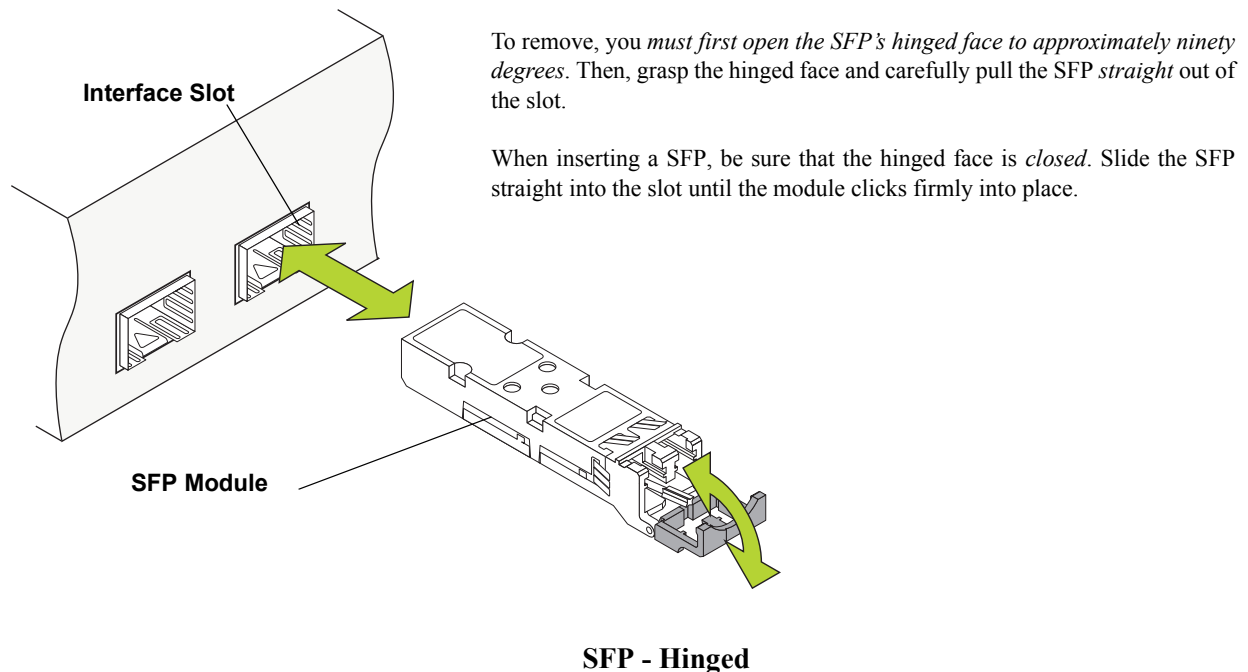

To install, align the transceiver with the transceiver slot on the NI module, as shown. Be sure that the bail wire delatch is in the *up, or closed position*. Slide the transceiver straight into the slot until the module clicks firmly into place.

To remove, you must first pull down on the bail wire delatch. Grip the wire delatch while it is in this open position and carefully pull the transceiver straight out of the slot.

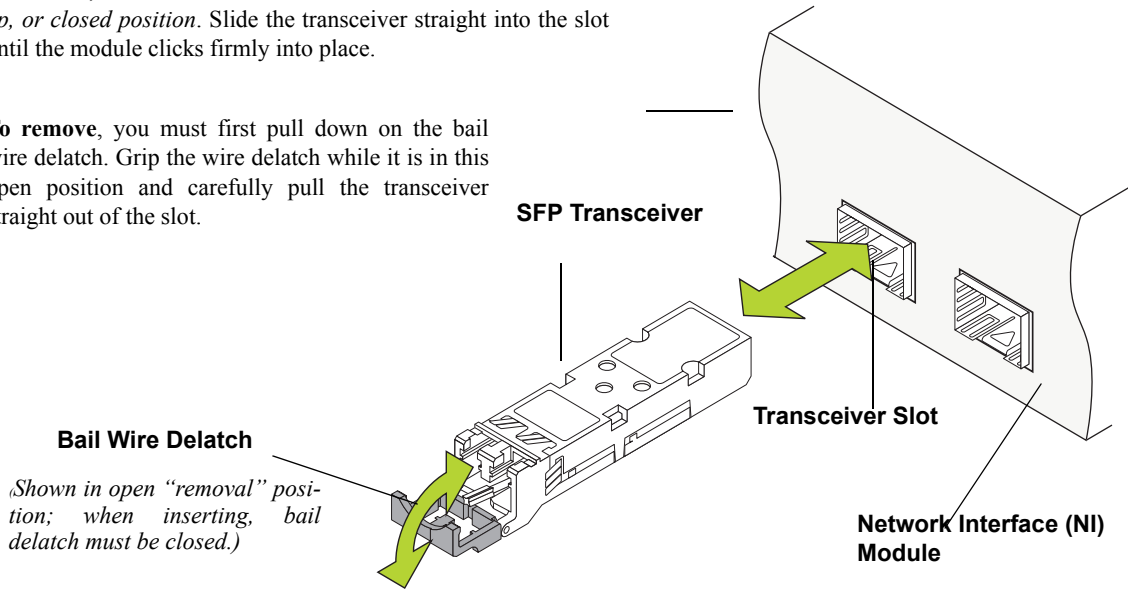

SFP - Bail Wire

To install, align the transceiver with the transceiver slot on the NI module, as shown. Carefully slide the transceiver back until it clicks into place; this is an indication that the connectors are firmly seated.

To remove, use the ejector tool (provided with each switch chassis) to push the transceiver's ejector button. The ejector button is located just below the transceiver port; refer to the diagram for more information. The transceiver will disengage from the connectors and eject slightly. Once disengaged, *use the clip end of the ejector tool* to carefully pull the transceiver straight out and away from the NI module.

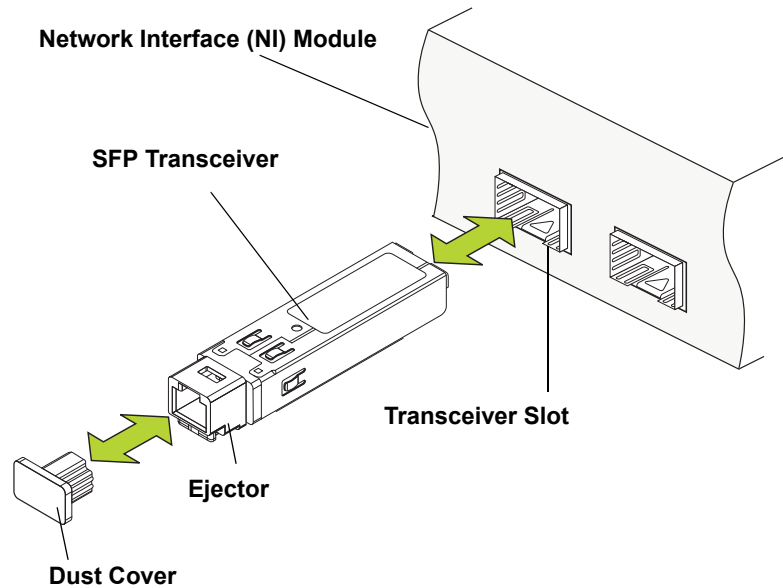

SFP - Ejector Button

To install, align the transceiver with the transceiver slot on the NI module, as shown. Carefully slide the transceiver back until it clicks into place; this is an indication that the connectors are firmly seated.

To remove, use the rubber or metal ejector handle and pull transceiver straight out and away from the NI module.

Note: *Never force the transceiver in or out of the transceiver slot.*

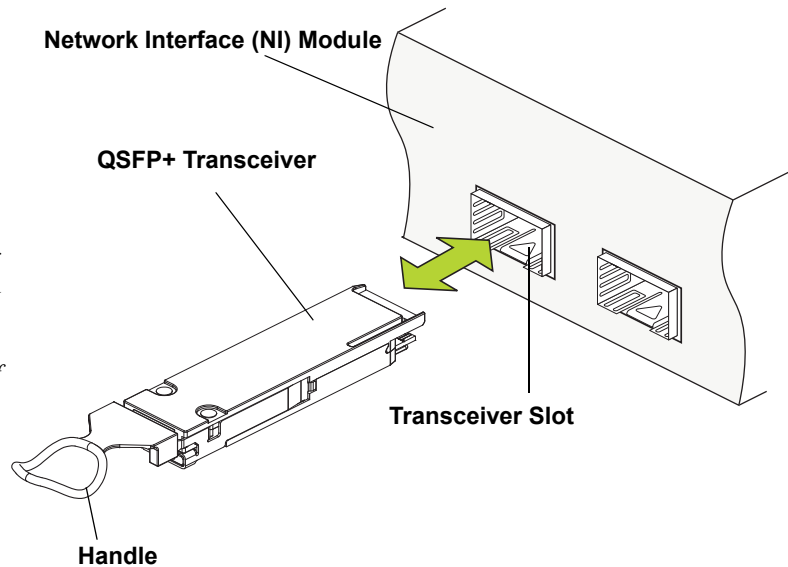

QSFP+ - Removal

40-Gigabit Fiber Optic Cables

QSFP to QSFP 40G Fiber Optic Cable

To directly connect two Omniswitches with a 40G transceiver, an MPO trunk cable can be used. The cable can have 8 or 12 fibers, however, the 40G standard only uses 8 fibers. The cable should be a Type-B cross-over cable. This type of cable should be used with the [QSFP-40G-SR](#) transceiver.

	Fiber	1	2	3	4	5-8	9	10	11	12
Type A	MPO1	Tx1	Tx2	Tx3	Tx4	N/A	Rx4	Rx3	Rx2	Rx1
	MPO2	Rx1	Rx2	Rx3	Rx4	N/A	Tx4	Tx3	Tx2	Tx1
Type B	Fiber	1	2	3	4	5-8	9	10	11	12
	MPO1	Rx1	Rx2	Rx3	Rx4	N/A	Tx4	Tx3	Tx2	Tx1
	MPO2	Tx1	Tx2	Tx3	Tx4	N/A	Rx4	Rx3	Rx2	Rx1
	Fiber	12	11	10	9	5-8	4	3	2	1

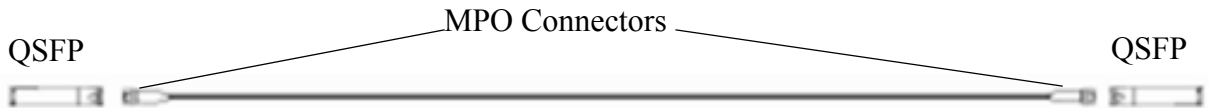

Example Type B - MPO Cable Connection

QSFP to SFP+ Splitter Fiber Optic Cable

To connect a 40G transceiver to four 10G transceivers an MTP-LC splitter cable can be used. The MPO-LC cable has eight fibers that connect the 40G MPO connector to four 10G LC connectors. This type of cable should be used with the [QSFP-4X10G-SR](#) transceiver. The LC connectors can be manually rearranged to meet the necessary transmit/receive requirements.

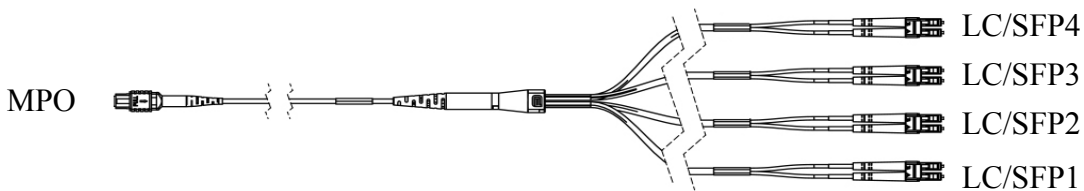

Example MPO/LC Splitter Cable

Gigabit Ethernet Transceivers

SFP-GIG-SX

Gigabit SFP Optical Transceiver.

Connector Type	LC
Standards Supported	802.3z, SFP MSA
Connections Supported	1000Base-SX
Fiber Type	MMF
Wavelength	850 nm
Optical Power Output	-9.0 to -2.5 dBm
Receiver Sensitivity	-17 dBm
Transmission Distance	~300 m on 62.5/125 μ m ~550 m on 50/125 μ m
Operating Temperature	-20 °C to 85°C
Digital Diagnostic Monitoring	Supported (Alcatel-Lucent branded transceivers only)

SFP-GIG-LX

Gigabit SFP Optical Transceiver.

Connector types	LC
Standards supported	802.3z, SFP MSA
Connections supported	1000Base-LX
Fiber Type	SMF
Wavelength	1310 nm
Optical Power Output	-9.5 to -3 dBm
Receiver Sensitivity	-14.5 dBm
Transmission Distance	~10 km
Operating Temperature	-40 °C to 85 °C / 0 °C to 70 °C
Digital Diagnostic Monitoring	Supported (Alcatel-Lucent branded transceivers only)

SFP-GIG-LH40

Gigabit SFP Optical Transceiver.

Connector Type	LC
Standards Supported	802.3z, SFP MSA
Connections Supported	1000Base-LH40r
Fiber Type	SMF
Wavelength	1310 nm
Optical Power Output	0 to +5 dBm
Receiver Sensitivity	-22 dBm
Transmission Distance	~40 km
Operating Temperature	-10 °C to 70 °C
Digital Diagnostic Monitoring	Supported

SFP-GIG-LH70

Gigabit SFP Optical Transceiver.

Connector Type	LC
Standards Supported	802.3z, SFP MSA
Connections Supported	1000Base-LH70
Fiber Type	SMF
Wavelength	1550 nm
Optical Power Output	0 to +5 dBm
Receiver Sensitivity	-22 dBm
Transmission Distance	~70 km
Operating Temperature	-10 °C to 70 °C
Digital Diagnostic Monitoring	Supported

SFP-GIG-CWD

Coarse Wavelength Division Multiplexing (CWDM) is an optical transceiver supporting single-mode fiber over various wavelengths. CWDMs are hot-pluggable and are available for long-reach applications.

Connector Type	LC
Standards Supported	802.3z, SFP MSA
Connections Supported	1000Base-LX
Fiber Type	SMF
Wavelength	1470, 1490, 1510, 1530, 1550, 1570, 1590, 1610
Optical Power Output	-2 to +3 dBm
Receiver Sensitivity	-24 dBm
Transmission Distances	~62 km
Operating Temperature	-5 °C to 70 °C
Digital Diagnostic Monitoring	Not Supported

SFP-GIG-T

Gigabit SFP Copper Transceiver.

Connector Type	RJ-45
Standards Supported	802.3z, SFP MSA
Connections supported	10/100/1000Base-T
Cable Type	CAT5, CAT5e, CAT6
Transmission Distance	~100 m
Digital Diagnostic Monitoring	Not Supported

SFP-GIG-EXTND

Gigabit SFP Optical Transceiver.

Connector Type	LC
Standards Supported	802.3, SFP MSA
Connections Supported	-
Fiber Type	MMF
Wavelength	1310 nm
Saturation Power	0 dBm
Transmission Distance	~2 km
Operating Temperature	0 °C to 70 °C
Digital Diagnostic Monitoring	Supported

SFP-GIG-BX-D

Bi-Directional SFP Optical Transceiver.

Connector Type	LC
Standards Supported	802.3ah, SFP MSA
Connections Supported	1000Base-BX10
Fiber Type	SMF
Wavelength	Transmit: 1490 nm Receive: 1310 nm
Average Power Output	-9 to -3 dBm
Receiver Sensitivity	-19.5 dBm
Transmission Distance	~10 km
Operating Temperature	0 °C to 70 °C
Digital Diagnostic Monitoring	Supported
Notes	Designed for use with SFP-GIG-BX-U

SFP-GIG-BX-U

Bi-Directional SFP Optical Transceiver.

Connector Type	LC
Standards Supported	802.3ah, SFP MSA
Connections Supported	1000Base-BX10
Fiber Type	SMF
Wavelength	Transmit: 1310 nm Receive: 1490 nm
Average Power Output	-9 to -3 dBm
Receiver Sensitivity	-19.5 dBm
Transmission Distance	~10 km
Operating Temperature	0 °C to 70 °C
Digital Diagnostic Monitoring	Supported
Notes	Designed for use with SFP-GIG-BX-D

SFP-GIG-BX-D20

Bi-Directional SFP Optical Transceiver.

Connector Type	LC
Standards Supported	802.3ah, SFP MSA
Connections Supported	1000Base-BX20
Fiber Type	SMF
Wavelength	Transmit: 1490 nm Receive: 1310 nm
Average Power Output	-8 to -3 dBm
Receiver Sensitivity	-23 dBm
Transmission Distance	~20 km
Operating Temperature	-5 °C to 70 °C
Digital Diagnostic Monitoring	Supported
Notes	Designed for use with SFP-GIG-BX-U20

SFP-GIG-BX-U20

Bi-Directional SFP Optical Transceiver.

Connector Type	LC
Standards Supported	802.3ah, SFP MSA
Connections Supported	1000Base-BX20
Fiber Type	SMF
Wavelength	Transmit: 130 nm Receive: 1490 nm
Average Power Output	-8 to -3 dBm
Receiver Sensitivity	-23 dBm
Transmission Distance	~20 km
Operating Temperature	-5 °C to 70 °C
Digital Diagnostic Monitoring	Supported
Notes	Designed for use with SFP-GIG-BX-D20

SFP-GIG-BX-D40

Bi-Directional SFP Optical Transceiver.

Connector Type	LC
Standards Supported	802.3ah, SFP MSA
Connections Supported	1000Base-BX40
Fiber Type	SMF
Wavelength	Transmit: 1490 nm Receive: 1310 nm
Average Power Output	-2 to +3 dBm
Receiver Sensitivity	-23 dBm
Transmission Distance	~40 km
Operating Temperature	-5 °C to 70 °C
Digital Diagnostic Monitoring	Supported
Notes	Designed for use with SFP-GIG-BX-U40

SFP-GIG-BX-U40

Bi-Directional SFP Optical Transceiver.

Connector Type	LC
Standards Supported	802.3ah, SFP MSA
Connections Supported	1000Base-BX20
Fiber Type	SMF
Wavelength	Transmit: 1310 nm Receive: 1490 nm
Average Power Output	-2 to +3 dBm
Receiver Sensitivity	-23 dBm
Transmission Distance	~40 km
Operating Temperature	-5 °C to 70 °C
Digital Diagnostic Monitoring	Supported
Notes	Designed for use with SFP-GIG-BX-D40

Dual Speed Ethernet Transceivers

SFP-DUAL-MM

Dual speed Optical Transceiver.

Connector Type	LC
Standards Supported	802.3z, 802.3ah, SFP MSA
Connections Supported	100Base-FX, 1000Base-LX
Fiber Type	MMF
Wavelength	1310 nm
Average Power Output	100Base-FX: -20 to -14 dBm 1000Base-LX: -11.5 to -3 dBm
Receiver Sensitivity	100Base-FX: -28 dBm 1000Base-LX: -22 dBm
Transmission Distance	550 m at 1000 Mbps 2 km at 100 Mbps
Operating Temperature	-5 °C to 70 °C
Digital Diagnostic Monitoring	Not Supported

SFP-DUAL-SM10

Dual speed Optical Transceiver.

Connector Type	LC
Standards Supported	802.3z, 802.3ah, SFP MSA
Connections Supported	100Base-FX, 1000Base-LX
Fiber Type	SMF
Wavelength	1310 nm
Average Power Output	100Base-FX: -15 to -8 dBm 1000Base-LX: -9.5 to -3 dBm
Receiver Sensitivity	100Base-FX: -28 dBm 1000Base-LX: -22 dBm
Transmission Distance	~10 km
Operating Temperature	0 °C to 70 °C
Digital Diagnostic Monitoring	Not Supported

SFP-DUAL-BX-D

Dual speed Optical Transceiver.

Connector Type	LC
Standards Supported	802.3z, 802.3ah, SFP MSA
Connections Supported	1000BASE-BX10-D
Fiber Type	SMF
Wavelength	Transmit: 1550 nm Receive: 1310 nm
Average Power Output	-9 to -3 dBm
Receiver Sensitivity	-18.7 dBm
Transmission Distance	~10 km
Operating Temperature	-5 °C to 70 °C
Digital Diagnostic Monitoring	Supported

SFP-DUAL-BX-U

Dual speed Optical Transceiver.

Connector Type	LC
Standards Supported	802.3z, 802.3ah, SFP MSA
Connections Supported	1000BASE-BX10-U
Fiber Type	SMF
Wavelength	Transmit: 1310 nm Receive: 1550 nm
Average Power Output	-9 to -3 dBm
Receiver Sensitivity	-18.7 dBm
Transmission Distance	~10 km
Operating Temperature	-5 °C to 70 °C
Digital Diagnostic Monitoring	Supported

100 FX Ethernet Transceivers

SFP-100-BX20LT

Bi-Directional SFP Optical Transceiver.

Connector Type	SC
Standards Supported	802.3ah, SFP MSA, ITU-T G.983
Connections Supported	100Base-BX
Fiber Type	SMF
Wavelength	Transmit: 1550 nm Receive: 1310 nm
Average Power Output	-14 to -8 dBm
Receiver Sensitivity	-32 dBm
Transmission Distance	~20 km
Operating Temperature	0 °C to 70 °C
Digital Diagnostic Monitoring	Supported
Notes	Designed for use with SFP-100-BX20NU

SFP-100-BX20NU

Bi-Directional SFP Optical Transceiver.

Connector Type	SC
Standards Supported	802.3ah, SFP MSA, ITU-T G.983
Connections Supported	100Base-BX
Fiber Type	SMF
Wavelength	Transmit: 1310 nm Receive: 1550 nm
Average Power Output	-14 to -8 dBm
Receiver Sensitivity	-32 dBm
Transmission Distance	~20 km
Operating Temperature	0 °C to 70 °C
Digital Diagnostic Monitoring	Supported
Notes	Designed for use with SFP-100-BX20LT

SFP-100-BXLC-D

Bi-Directional SFP Optical Transceiver.

Connector Type	LC
Standards Supported	802.3ah, SFP MSA, ITU-T G.983
Connections Supported	100Base-BX
Fiber Type	SMF
Wavelength	Transmit: 1550 nm Receive: 1310 nm
Average Power Output	-14 to -8 dBm
Receiver Sensitivity	-32 dBm
Transmission Distance	~20 km
Operating Temperature	0 °C to 70 °C
Digital Diagnostic Monitoring	Supported
Notes	Designed for use with SFP-100-BXLC-U

SFP-100-BXLC-U

Bi-Directional SFP Optical Transceiver.

Connector Type	LC
Standards Supported	802.3ah, SFP MSA, ITU-T G.983
Connections Supported	100Base-BX
Fiber Type	SMF
Wavelength	Transmit: 1310 nm Receive: 1550 nm
Average Power Output	-14 to -8 dBm
Receiver Sensitivity	-32 dBm
Transmission Distance	~20 km
Operating Temperature	0 °C to 70 °C
Digital Diagnostic Monitoring	Supported
Notes	Designed for use with SFP-100-BXLC-D

SFP-100-LC-MM

SFP Optical Transceiver.

Connector Type	LC
Standards Supported	802.3u, SFP MSA
Connections supported	100Base-FX
Fiber Type	MMF
Wavelength	1310 nm
Optical Power Output	-19 to -14 dBm on 62.5/125 μ m -22 to 14 dBm on 50/125 μ m
Transmission Distance	~2 km on 62.5/125 μ m ~2 km on 50/125 μ m
Operating Temperature	0 °C to 70 °C
Digital Diagnostic Monitoring	Not Supported

SFP-100-LC-SM15

SFP Optical Transceiver.

Connector Type	LC
Standards Supported	802.3u, SFP MSA
Connections Supported	100Base-FX
Fiber Type	SMF
Wavelength (nm)	1310 nm
Optical Power Output	-15 to -8 dBm
Receiver Sensitivity	-34 dBm
Transmission Distance	~15 km
Operating Temperature	0 °C to 70 °C
Digital Diagnostic Monitoring	Not Supported

SFP-100-LC-SM40

SFP Optical Transceiver.

Connector Type	LC
Standards Supported	802.3u, SFP MSA
Connections Supported	100Base-FX
Fiber Type	SMF
Wavelength	1310 nm
Optical Power Output	-15 to -8 dBm
Receiver Sensitivity	-34 dBm
Transmission Distances	~40 km
Operating Temperature	0 °C to 70 °C
Digital Diagnostic Monitoring	Not Supported

10-Gigabit SFP+ Transceivers

SFP-10G-SR

10-Gigabit SFP+ Optical Transceiver.

Connector Type	LC
Standards Supported	802.3 Clause 52
Connections supported	10GBase-SR
Fiber Type	MMF
Wavelength	850 nm
Optical Power Output	-7.3 to -3.0 dBm
Receiver Sensitivity	-11.1 dBm
Transmission Distance	~ 300 m
Operating Temperature	-5 °C to 70°C
Maximum Power Consumption	1 W
Digital Diagnostic Monitoring	Supported

SFP-10G-LR

10-Gigabit SFP+ Optical Transceiver.

Connector Type	LC
Standards Supported	802.3 Clause 52
Connections supported	10GBase-LR
Fiber Type	SMF
Wavelength	1310 nm
Optical Power Output	-8.2 to 0.5 dBm
Receiver Sensitivity	-10.3 dBm
Transmission Distance	~ 10 km
Operating Temperature	-5 °C to 70°C
Maximum Power Consumption	1 W
Digital Diagnostic Monitoring	Supported

SFP-10G-ER

10-Gigabit SFP+ Optical Transceiver.

Connector Type	LC
Standards Supported	802.3ae
Connections supported	10GBase-E
Fiber Type	SMF
Wavelength	1550 nm
Optical Power Output	-4.7 to 4.0 dBm
Receiver Sensitivity	-14.1 dBm
Transmission Distance	~ 40 km
Operating Temperature	-5 °C to 70 °C
Maximum Power Consumption	1.5 W
Digital Diagnostic Monitoring	Supported

SFP-10G-LRM

10-Gigabit SFP+ Optical Transceiver.

Connector Type	LC
Standards Supported	802.3aq
Connections supported	10GBase-LRM
Fiber Type	MMF
Wavelength	1310 nm
Optical Power Output	-4.5 to 1.5dBm
Receiver Sensitivity	-6.5 dBm
Transmission Distance	~ 220 m
Operating Temperature	-5 °C to 70°C
Maximum Power Consumption	1 Watt
Digital Diagnostic Monitoring	Supported

SFP-10G-ZR

10-Gigabit SFP+ Optical Transceiver.

Connector Type	LC
Standards Supported	802.3ae
Connections supported	10GBase-ZR
Fiber Type	SMF

SFP-10G-ZR

10-Gigabit SFP+ Optical Transceiver.

Wavelength	1550 nm
Optical Power Output	0 to +5 dBm
Receiver Sensitivity	-20 dBm
Transmission Distance	~ 80 km
Operating Temperature	-5 °C to 70 °C
Maximum Power Consumption	1.2 W
Digital Diagnostic Monitoring	Supported

SFP-10G-T

10-Gigabit SFP+ Copper Transceiver.

Connector Type	RJ-45
Standards Supported	802.3az
Connections supported	10GBaseT
Cable Type	CAT6a/7
Transmission Distance	~30 m
Digital Diagnostic Monitoring	Not Supported

SFP-10G-C

10-Gigabit SFP+ Direct Attach Copper Cable.

Connector Type	Direct Attached Copper
Standards Supported	802.3ae, SFF-8431
Cable Length	1m, 3m, 7m ¹
Wire Gauge	24AWG
Bend Radius	1.25 in.
Digital Diagnostic Monitoring	Not Supported

1. Check for availability of additional supported lengths.

SFP-10G-24DWD80

10-Gigabit SFP+ Optical Transceiver.

Connector Type	LC
----------------	----

SFP-10G-24DWD80

10-Gigabit SFP+ Optical Transceiver.

Standards Supported	802.3ae
Connections supported	10GBase-ZR
Fiber Type	SMF
Wavelength	1558.17 nm
Optical Power Output	0 to 5dBm
Receiver Sensitivity	-23 dBm
Transmission Distance	~ 80 km
Operating Temperature	-5°C to 70°C
Maximum Power Consumption	1.2 Watt
Digital Diagnostic Monitoring	Supported

SFP-10G-GIG-SR

10-Gigabit SFP+ Optical Transceiver.

Connector Type	LC
Standards Supported	802.3-2005
Connections supported	10GBase-SR/SW, 1000Base-SX
Fiber Type	MMF
Wavelength	850 nm
Optical Power Output	-5 to -1 @ 10G -9.5 to -1dBm @ 1G
Receiver Sensitivity	-11.1 dBm @ 10G -17 dBm @ 1G
Transmission Distance	OM1: ~33m @ 10G, ~275m @ 1G OM2: ~82m @ 10G, ~550m @ 1G OM3: ~300m @ 10G, ~550m @ 1G
Operating Temperature	0°C to 70°C
Maximum Power Consumption	<1.0 Watt
Digital Diagnostic Monitoring	Supported

SFP-10G-GIG-LR

10-Gigabit SFP+ Optical Transceiver.

Connector Type	LC
Standards Supported	802.3-2005
Connections supported	10GBase-LR/LW, 1000Base-LX

SFP-10G-GIG-LR

10-Gigabit SFP+ Optical Transceiver.

Fiber Type	SMF
Wavelength	1310 nm
Optical Power Output	-8.2 to +5 dBm @ 10G -11 to -3 dBm @ 1G
Receiver Sensitivity	-12.6 dBm @ 10G -19 dBm @ 1G
Transmission Distance	~10 km
Operating Temperature	-5°C to 70°C
Maximum Power Consumption	<1.0 Watt
Digital Diagnostic Monitoring	Supported

40-Gigabit QSFP+ Transceivers

CAUTION - CLASS 1M LASER RADIATION WHEN OPEN. DO NOT VIEW DIRECTLY WITH OPTICAL INSTRUMENTS.

QSFP-40G-SR

Four channel 40-Gigabit QSFP+ Optical Transceiver.

Connector Type	MPO
Standards Supported	802.3ba, QSFP+ MSA
Connections supported	40GBase-SR4
Fiber Type	MMF
Wavelength	850 nm
Optical Power Output	-7.6 to +2.4 dBm
Receiver Sensitivity	-5.4 dBm
Transmission Distance	OM3 - ~ 100 m OM4 - ~150 m
Operating Temperature	0 °C to 70°C
Maximum Power Consumption	1.5 W
Digital Diagnostic Monitoring	Supported ¹

QSFP-40G-SR-BD

Four channel 40-Gigabit QSFP+ Optical Transceiver.

Connector Type	LC
Standards Supported	802.3ba-2010, QSFP+ MSA
Connections supported	40GBase-SR4
Fiber Type	MMF
Wavelength	850 / 900 nm
Optical Power Output	-4.0 to +5.0 dBm
Receiver Sensitivity	-7.1 / -7.7 dBm
Transmission Distance	OM3 - ~ 100 m OM4 - ~150 m
Operating Temperature	10 °C to 70°C
Maximum Power Consumption	3.5 W
Digital Diagnostic Monitoring	Not Supported

QSFP-40G-LR

Four channel 40-Gigabit QSFP+ Optical Transceiver.

Connector Type	LC
Standards Supported	802.3ba, QSFP+ MSA
Connections supported	40GBase-LR4
Fiber Type	SMF
Wavelength	1310 nm
Optical Power Output	-7.0 to +2.3 dBm
Receiver Sensitivity	-11.5 dBm
Transmission Distance	10 km
Operating Temperature	0 °C to 70°C
Maximum Power Consumption	< 3.5 W
Digital Diagnostic Monitoring	Supported ¹

1. Supports the DDM parameters of Voltage (V), Temperature (T), Current (mA) and Input (dBm). If the threshold values of the transceiver are '0' then NS will be displayed in the DDM output display.

QSFP-40G-C

Four channel 40-Gigabit QSFP+ Direct Attach Copper Cable

Connector Type	Direct Attached Copper
Standards Supported	802.3ba, QSFP+ MSA
Cable Length	40cm, 1m, 3m, 7m ^{1,2}
Wire Gauge	26AWG
Bend Radius	1.69 in.
Digital Diagnostic Monitoring	Not Supported

1. Check for availability of lengths.

2. The QSFP-40G-C7 (7m) cable has been verified for proper operation when connected between OmniSwitch products. When connecting this cable between an OmniSwitch and other vendors' equipment, it's recommended to verify proper operation prior to network deployment.

QSFP-4X10G-SR

Four channel 40-Gigabit QSFP+ Optical Transceiver. Connects a single 40G QSFP+ port to four 10G SFP+ ports

Connector Type	MPO
Standards Supported	802.3ba, 802.3ae, QSFP+ MSA
Connections supported	40GBase-SR4, 10GBase-SR

QSFP-4X10G-SR

Four channel 40-Gigabit QSFP+ Optical Transceiver. Connects a single 40G QSFP+ port to four 10G SFP+ ports

Fiber Type	MMF
Wavelength	850 nm
Optical Power Output	-7.5 to +0.5 dBm
Receiver Sensitivity	-7.5 dBm (SRS)
Transmission Distance	OM3 - ~ 300 m OM4 - ~400 m
Operating Temperature	0 °C to 70°C
Maximum Power Consumption	1.5 W
Digital Diagnostic Monitoring	Supported

QSFP-4X10G-C

Four channel 40-Gigabit QSFP+ Direct Attached Copper Splitter Cable. Connects a single 40G QSFP+ port to four 10G SFP+ ports

Connector Type	Direct Attached Copper Splitter Cable
Cable Length	1m, 3m, 5m
Digital Diagnostic Monitoring	Not Supported

QSFP-40G-AOC20M

Description	Four channel 40-Gigabit QSFP+ active optical cable
Connector Type	Direct attached
Standards Supported	802.3ba, QSFP+ MSA
Connections supported	40GBase-SR4
Cable Length	20 m
Bend Radius	45 mm
Operating Temperature	0 °C to 70°C
Maximum Power Consumption	< 1.3 W
Digital Diagnostics Monitoring	Supported

OS6860-CBL-100

Description	20-Gigabit QSFP+ direct attached copper transceiver.
-------------	--

OS6860-CBL-100

Connector Type	Direct Attached Copper
Standards Supported	802.3ba, QSFP+ MSA
Cable Length	1m
Wire Gauge	26AWG
Bend Radius	1.69 in.
Digital Diagnostics Monitoring	Not Supported

OS6860-CBL-300

Description	20-Gigabit QSFP+ direct attached copper transceiver.
Connector Type	Direct Attached Copper
Standards Supported	802.3ba, QSFP+ MSA
Cable Length	3m
Wire Gauge	26AWG
Bend Radius	1.69 in.
Digital Diagnostics Monitoring	Not Supported

OS6860-CBL-40

Description	20-Gigabit QSFP+ direct attached copper transceiver.
Connector Type	Direct Attached Copper
Standards Supported	802.3ba, QSFP+ MSA
Cable Length	40cm
Wire Gauge	26AWG
Bend Radius	1.69 in.
Digital Diagnostics Monitoring	Not Supported

Fibre Channel Transceivers

SFP-FC-SR

Triple-speed SFP+ Fibre Channel optical transceiver.

Connector Type	LC
Standards Supported	FC-P1-4
Connections supported	Auto-sensing 2G, 4G, 8G
Fiber Type	MMF
Wavelength	850 nm
Average Optical Power Output	-8.2 dBm
Transmission Distance ¹	OM3: ~150m @ 8Gbps, 310m @ 4Gbps, 500m @ 2Gbps OM1: ~21m @ 8Gbps, 70m @ 4Gbps, 150m @ 2Gbps
Operating Temperature	0 °C to 85°C
Maximum Power Consumption	3.3 V
Digital Diagnostic Monitoring	Supported

1. Distances based on FC-P1-4 specification.

Industrial Transceivers

iSFP-GIG-SX

Gigabit SFP Optical Transceiver.

Connector Type	LC
Standards Supported	802.3z, SFP MSA
Connections Supported	1000Base-SX
Fiber Type	MMF
Wavelength	850 nm
Optical Power Output	-9.0 to -2.5 dBm
Receiver Sensitivity	-18 dBm
Transmission Distance	~300 m on 62.5/125 μ m ~500 m on 50/125 μ m
Operating Temperature	-40°C to 85°C
Digital Diagnostic Monitoring	Supported

iSFP-GIG-LX

Gigabit SFP Optical Transceiver.

Connector types	LC
Standards supported	802.3z, SFP MSA
Connections supported	1000Base-LX
Fiber Type	SMF
Wavelength	1310 nm
Optical Power Output	-9.5 to -3 dBm
Receiver Sensitivity	-14.5 dBm
Transmission Distance	~10 km
Operating Temperature	-40 °C to 85 °C / 0 °C to 70 °C
Digital Diagnostic Monitoring	Supported (Alcatel-Lucent branded transceivers only)

iSFP-GIG-LH40

Gigabit SFP Optical Transceiver.

Connector Type	LC
Standards Supported	802.3z, SFP MSA
Connections Supported	1000Base-LH40
Fiber Type	SMF
Wavelength	1310 nm
Optical Power Output	-2 to +3 dBm
Receiver Sensitivity	-23 dBm
Transmission Distance	~40 km
Operating Temperature	-40 °C to 85 °C
Digital Diagnostic Monitoring	Supported

iSFP-GIG-LH70

Gigabit SFP Optical Transceiver.

Connector Type	LC
Standards Supported	802.3z, SFP MSA
Connections Supported	1000Base-LH70
Fiber Type	SMF
Wavelength	1550 nm
Optical Power Output	0 to +5 dBm
Receiver Sensitivity	-22 dBm
Transmission Distance	~70 km
Operating Temperature	-10 °C to 70 °C
Digital Diagnostic Monitoring	Supported

iSFP-GIG-T

Gigabit SFP Copper Transceiver.

Connector Type	RJ-45
Standards Supported	802.3z, SFP MSA
Connections supported	10/100/1000Base-T
Cable Type	CAT5, CAT5e, CAT6
Transmission Distance	~100 m
Digital Diagnostic Monitoring	Not Supported

iSFP-GIG-BX-D

Bi-Directional SFP Optical Transceiver.

Connector Type	LC
Standards Supported	802.3ah, SFP MSA
Connections Supported	1000Base-BX10
Fiber Type	SMF
Wavelength	Transmit: 1490 nm Receive: 1310 nm
Average Power Output	-9 to -3 dBm
Receiver Sensitivity	-19.5 dBm
Transmission Distance	~10 km
Operating Temperature	-40 °C to 85 °C
Digital Diagnostic Monitoring	Supported
Notes	Designed for use with iSFP-GIG-BX-U

iSFP-GIG-BX-U

Bi-Directional SFP Optical Transceiver.

Connector Type	LC
Standards Supported	802.3ah, SFP MSA
Connections Supported	1000Base-BX10
Fiber Type	SMF
Wavelength	Transmit: 1310 nm Receive: 1490 nm
Average Power Output	-9 to -3 dBm

iSFP-GIG-BX-U

Bi-Directional SFP Optical Transceiver.

Receiver Sensitivity	-19.5 dBm
Transmission Distance	~10 km
Operating Temperature	0 °C to 70 °C
Digital Diagnostic Monitoring	Supported
Notes	Designed for use with iSFP-GIG-BX-D

iSFP-10G-SR

10-Gigabit SFP+ Optical Transceiver.

Connector Type	LC
Standards Supported	802.3 Clause 52
Connections supported	10GBase-SR
Fiber Type	MMF
Wavelength	850 nm
Optical Power Output	-7.3 to -3.0 dBm
Receiver Sensitivity	-11.1 dBm
Transmission Distance	~ 300 m
Operating Temperature	-5 °C to 70°C
Maximum Power Consumption	1 W
Digital Diagnostic Monitoring	Supported

iSFP-10G-LR

10-Gigabit SFP+ Optical Transceiver.

Connector Type	LC
Standards Supported	802.3 Clause 52
Connections supported	10GBase-LR
Fiber Type	SMF
Wavelength	1310 nm
Optical Power Output	-8.2 to 0.5 dBm
Receiver Sensitivity	-10.3 dBm
Transmission Distance	~ 10 km
Operating Temperature	-5 °C to 70°C
Maximum Power Consumption	1 W
Digital Diagnostic Monitoring	Supported

iSFP-10G-ER

10-Gigabit SFP+ Optical Transceiver.

Connector Type	LC
Standards Supported	802.3ae
Connections supported	10GBase-E
Fiber Type	SMF
Wavelength	1550 nm
Optical Power Output	-4.7 to 4.0 dBm
Receiver Sensitivity	-14.1 dBm
Transmission Distance	~ 40 km
Operating Temperature	-5 °C to 70 °C
Maximum Power Consumption	1.5 W
Digital Diagnostic Monitoring	Supported

iSFP-10G-C

10-Gigabit SFP+ Direct Attach Copper Cable.

Connector Type	Direct Attached Copper
Standards Supported	802.3ae, SFF-8431
Cable Length	1m, 3m, 7m ¹
Wire Gauge	24AWG
Bend Radius	1.25 in.
Digital Diagnostic Monitoring	Not Supported

1. Check for availability of lengths.

2 Transceiver Compatibility Matrix

In This Chapter

The following sections document the transceiver configurations and minimum release required for support on the OmniSwitch.

Compatibility specifications in this chapter include:

- OmniSwitch 10K . See [“OmniSwitch 10K Compatibility”](#) on page 2-35
- OmniSwitch 6900 . See [“OmniSwitch 6900 Compatibility”](#) on page 2-37
- OmniSwitch 6860. See [“OmniSwitch 6860 Compatibility”](#) on page 2-39
- OmniSwitch 6865. See [“OmniSwitch 6865 Compatibility”](#) on page 2-41
- OmniSwitch 9900. See [“OmniSwitch 9900 Compatibility”](#) on page 2-42

Note: For transceivers supporting Digital Diagnostics Monitoring there may be a slight variance between actual and reported values for both the transmit and receive side depending on the transceiver.

OmniSwitch 10K Compatibility

The following table shows the available transceivers and minimum release required for support:

Transceiver	OS10K-GNI-U48	OS10K-XNI U32/U16	OS10K-QNI U4/U8
SFP-GIG-SX	7.1.1	7.1.1	Not Supported
SFP-GIG-LX	7.1.1	7.1.1	Not Supported
SFP-GIG-LH40	7.1.1	7.1.1	Not Supported
SFP-GIG-LH70	7.1.1	7.1.1	Not Supported
SFP-GIG-CWD	7.1.1	7.1.1	Not Supported
SFP-GIG-T	7.1.1	7.1.1 ¹	Not Supported
SFP-GIG-EXTND	7.1.1	7.1.1	Not Supported
SFP-GIG-BX-D	7.1.1	7.1.1	Not Supported
SFP-GIG-BX-U	7.1.1	7.1.1	Not Supported
SFP-GIG-BX-D20	Not Supported	Not Supported	Not Supported
SFP-GIG-BX-U20	Not Supported	Not Supported	Not Supported
SFP-GIG-BX-D40	Not Supported	Not Supported	Not Supported
SFP-GIG-BX-U40	Not Supported	Not Supported	Not Supported
SFP-DUAL-MM	Not Supported	Not Supported	Not Supported
SFP-DUAL-SM10	Not Supported	Not Supported	Not Supported
SFP-DUAL-BX-D	Not Supported	Not Supported	Not Supported
SFP-DUAL-BX-U	Not Supported	Not Supported	Not Supported
SFP-100-BX20LT	7.1.1	Not Supported	Not Supported
SFP-100-BX20NU	7.1.1	Not Supported	Not Supported
SFP-100-BXLC-D	7.1.1	Not Supported	Not Supported
SFP-100-BXLC-U	7.1.1	Not Supported	Not Supported
SFP-100-LC-MM	7.1.1	Not Supported	Not Supported
SFP-100-LC-SM15	7.1.1	Not Supported	Not Supported
SFP-100-LC-SM40	7.1.1	Not Supported	Not Supported
SFP-10G-SR	Not Supported	7.1.1	Not Supported
SFP-10G-LR	Not Supported	7.1.1	Not Supported
SFP-10G-ER	Not Supported	7.1.1	Not Supported
SFP-10G-LRM	Not Supported	7.1.1	Not Supported
SFP-10G-ZR	Not Supported	7.3.4	Not Supported

Transceiver	OS10K-GNI-U48	OS10K-XNI U32/U16	OS10K-QNI U4/U8
SFP-10G-T	Not Supported	Not Supported	Not Supported
SFP-10G-C	Not Supported	7.1.1	Not Supported
SFP-10G-24DWD80	Not Supported	7.3.1	Not Supported
SFP-10G-GIG-SR	Not Supported	7.3.1	Not Supported
SFP-10G-GIG-LR	Not Supported	Not Supported	Not Supported
SFP-FC-SR	Not Supported	Not supported	Not Supported
QSFP-40G-SR	Not Supported	Not Supported	7.3.1.R01
QSFP-40G-SR-BD	Not Supported	Not supported	Not Supported
QSFP-40G-LR	Not Supported	Not Supported	7.3.1.R01
QSFP-40G-C	Not Supported	Not Supported	7.3.1.R01
QSFP-4X10G-SR	Not Supported	Not Supported	Not Supported
QSFP-4X10G-C	Not Supported	Not Supported	Not Supported
QSFP-40G-AOC20M	Not Supported	Not Supported	Not Supported

1. Only supports 1000-Mbits when used on OS10K-XNI-U32.

OmniSwitch 6900 Compatibility

The following table shows the available transceivers and minimum release required for support:

Transceiver	OS6900-X20/X40	OS6900-Q32	OS6900-X72	XNI-U4/U12	HNI-U6	QNI-U3	XNI-U12E
SFP-GIG-SX	7.2.1	N/S	7.3.4.R02	7.2.1	7.2.1.R02	N/S	7.3.3
SFP-GIG-LX	7.2.1	N/S	7.3.4.R02	7.2.1	7.2.1.R02	N/S	7.3.3
SFP-GIG-LH40	7.2.1	N/S	7.3.4.R02	7.2.1	7.2.1.R02	N/S	7.3.3
SFP-GIG-LH70	7.2.1	N/S	7.3.4.R02	7.2.1	7.2.1.R02	N/S	7.3.3
SFP-GIG-CWD	N/S	N/S	N/S	N/S	N/S	N/S	N/S
SFP-GIG-T	7.2.1 ¹	N/S	7.3.4.R02 ¹	7.2.1 ¹	N/S	N/S	7.3.3 ¹
SFP-GIG-EXTND	7.2.1	N/S	7.3.4.R02	7.2.1	N/S	N/S	7.3.3
SFP-GIG-BX-D	7.2.1	N/S	7.3.4.R02	7.2.1	7.2.1	N/S	7.3.3
SFP-GIG-BX-U	7.2.1	N/S	7.3.4.R02	7.2.1	7.2.1	N/S	7.3.3
SFP-GIG-BX-D20	Not Supported						
SFP-GIG-BX-U20	Not Supported						
SFP-GIG-BX-D40	Not Supported						
SFP-GIG-BX-U40	Not Supported						
SFP-DUAL-MM	Not Supported						
SFP-DUAL-SM10	Not Supported						
SFP-DUAL-BX-D	Not Supported						
SFP-DUAL-BX-U	Not Supported						
SFP-100-BX20LT	Not Supported						
SFP-100-BX20NU	Not Supported						
SFP-100-BXLC-D	Not Supported						
SFP-100-BXLC-U	Not Supported						
SFP-100-LC-MM	Not Supported						
SFP-100-LC-SM15	Not Supported						
SFP-100-LC-SM40	Not Supported						
SFP-10G-SR	7.2.1	N/S	7.3.4.R02	7.2.1	7.2.1	N/S	7.3.3
SFP-10G-LR	7.2.1	N/S	7.3.4.R02	7.2.1	7.2.1	N/S	7.3.3
SFP-10G-ER	7.2.1	N/S	7.3.4.R02	7.2.1	7.2.1	N/S	7.3.3
SFP-10G-LRM	7.2.1	N/S	N/S	7.2.1	7.2.1	N/S	7.3.3
SFP-10G-ZR	7.3.4	N/S	7.3.4.R02	7.3.4	7.3.4	N/S	7.3.4

Transceiver	OS6900-X20/X40	OS6900-Q32	OS6900-X72	XNI-U4/U12	HNI-U6	QNI-U3	XNI-U12E
SFP-10G-T	N/S	N/S	N/S	N/S	N/S	N/S	N/S
SFP-10G-C	7.2.1	N/S	7.3.4.R02	7.2.1	7.2.1	N/S	7.3.3
SFP-10G-24DWD80	7.3.1	N/S	7.3.4.R02	7.3.1	7.3.1	N/S	7.3.3
SFP-10G-GIG-SR	7.3.1	N/S	7.3.4.R02	7.3.1	7.3.1	N/S	7.3.3
SFP-10G-GIG-LR	Not Supported						
SFP-FC-SR	N/S	N/S	N/S	N/S	N/S	N/S	7.3.3
QSFP-40G-SR	N/S	7.3.4	7.3.4.R02	N/S	7.2.1.R02	7.2.1.R02	N/S
QSFP-40G-SR-BD	N/S	N/S	N/S	N/S	N/S	N/S	N/S
QSFP-40G-LR	N/S	7.3.4	7.3.4.R02	N/S	7.3.1.R01	7.3.1.R01	N/S
QSFP-40G-C	N/S	7.3.4	7.3.4.R02	N/S	7.2.1.R02	7.2.1.R02	N/S
QSFP-4X10G-SR	N/S	7.3.4	7.3.4.R02	N/S	N/S	N/S	N/S
QSFP-4X10G-C	N/S	7.3.4	7.3.4.R02	N/S	N/S	N/S	N/S
QSFP-40G-AOC-20M				N/S			

1. Only supports 1G.

OmniSwitch 6860 Compatibility

The following table shows the available transceivers and minimum release required for support:

Transceiver	OS6860/6860E (Excluding U28)	OS6860E-U28
SFP-GIG-SX	8.1.1	8.1.1
SFP-GIG-LX	8.1.1	8.1.1
SFP-GIG-LH40	8.1.1	8.1.1
SFP-GIG-LH70	8.1.1	8.1.1
SFP-GIG-CWD	8.1.1	8.1.1
SFP-GIG-T¹	8.1.1	8.1.1
SFP-GIG-EXTND	8.1.1	8.1.1
SFP-GIG-BX-D	8.1.1	8.1.1
SFP-GIG-BX-U	8.1.1	8.1.1
SFP-GIG-BX-D20	8.1.1	8.1.1
SFP-GIG-BX-U20	8.1.1	8.1.1
SFP-GIG-BX-D40	8.1.1	8.1.1
SFP-GIG-BX-U40	8.1.1	8.1.1
SFP-DUAL-MM²	N/S	8.1.1
SFP-DUAL-SM10²	N/S	8.1.1
SFP-DUAL-BX-D²	N/S	8.1.1
SFP-DUAL-BX-U²	N/S	8.1.1
SFP-100-BX20LT	N/S	N/S
SFP-100-BX20NU	N/S	N/S
SFP-100-BXLC-D²	N/S	8.1.1
SFP-100-BXLC-U²	N/S	8.1.1
SFP-100-LC-MM²	N/S	8.1.1
SFP-100-LC-SM15²	N/S	8.1.1
SFP-100-LC-SM40²	N/S	8.1.1
SFP-10G-SR	8.1.1	8.1.1
SFP-10G-LR	8.1.1	8.1.1
SFP-10G-ER	8.1.1	8.1.1
SFP-10G-LRM	8.1.1	8.1.1
SFP-10G-ZR	8.2.1	8.2.1
SFP-10G-T	N/S	N/S
SFP-10G-C	8.1.1	8.1.1
SFP-10G-24DWD80	N/S	N/S

Transceiver	OS6860/6860E (Excluding U28)	OS6860E-U28
SFP-10G-GIG-SR³	8.1.1	8.1.1
SFP-10G-GIG-LR³	8.2.1	8.2.1
SFP-FC-SR	N/S	N/S
QSFP-40G-SR⁴	8.1.1	8.1.1
QSFP-40G-SR-BD	N/S	N/S
QSFP-40G-LR	N/S	N/S
QSFP-40G-C	N/S	N/S
QSFP-4X10G-SR	N/S	N/S
QSFP-4X10G-C	N/S	N/S
QSFP-40G-AOC20M	8.2.1	8.2.1
OS6860-CBL-100⁴	8.1.1	8.1.1
OS6860-CBL-300⁴	8.1.1	8.1.1
OS6860-CBL-40⁴	8.1.1	8.1.1

1. OS6860E-U28 user ports (1 - 28) support 10/100/1000. All 6860 uplink ports support 1Gbps only with this transceiver. If manually setting the user port speed to 10M the transceiver must first be inserted before setting the speed.

2. Supported on OS6860E-U28 1G SFP user ports (1 - 28) only.

3. Not supported on OS6860E-U28 1G SFP user ports (1-28).

4. Supported for 20-Gigabit VFL connections only.

OmniSwitch 6865 Compatibility

The following table shows the available transceivers and minimum release required for support:

Transceiver	OS6865-P16X
iSFP-GIG-SX	8.3.1
iSFP-GIG-LX	8.3.1
iSFP-GIG-LH40	8.3.1
iSFP-GIG-LH70	8.3.1
iSFP-GIG-T	8.3.1
iSFP-GIG-BX-D	8.3.1
iSFP-GIG-BX-U	8.3.1
iSFP-10G-SR	8.3.1
iSFP-10G-LR	8.3.1
iSFP-10G-ER	8.3.1
iSFP-10G-C	8.3.1

OmniSwitch 9900 Compatibility

The following table shows the available transceivers and minimum release required for support:

Transceiver	OS99-CMM	OS99-XNI-U48
SFP-GIG-SX	Not Supported	8.3.1
SFP-GIG-LX	Not Supported	8.3.1
SFP-GIG-LH40	Not Supported	8.3.1
SFP-GIG-LH70	Not Supported	8.3.1
SFP-GIG-CWD	Not Supported	Not Supported
SFP-GIG-T	Not Supported	8.3.1 ¹
SFP-GIG-EXTND	Not Supported	8.3.1
SFP-GIG-BX-D	Not Supported	8.3.1
SFP-GIG-BX-U	Not Supported	8.3.1
SFP-GIG-BX-D20	Not Supported	Not Supported
SFP-GIG-BX-U20	Not Supported	Not Supported
SFP-GIG-BX-D40	Not Supported	Not Supported
SFP-GIG-BX-U40	Not Supported	Not Supported
SFP-DUAL-MM	Not Supported	8.3.1.R02 ¹
SFP-DUAL-SM10	Not Supported	Not Supported
SFP-DUAL-BX-D	Not Supported	Not Supported
SFP-DUAL-BX-U	Not Supported	Not Supported
SFP-100-BX20LT	Not Supported	Not Supported
SFP-100-BX20NU	Not Supported	Not Supported
SFP-100-BXLC-D	Not Supported	Not Supported
SFP-100-BXLC-U	Not Supported	Not Supported
SFP-100-LC-MM	Not Supported	Not Supported
SFP-100-LC-SM15	Not Supported	Not Supported
SFP-100-LC-SM40	Not Supported	Not Supported
SFP-10G-SR	Not Supported	8.3.1
SFP-10G-LR	Not Supported	8.3.1
SFP-10G-ER	Not Supported	8.3.1
SFP-10G-LRM	Not Supported	8.3.1
SFP-10G-ZR	Not Supported	8.3.1
SFP-10G-T	Not Supported	8.3.1.R02
SFP-10G-C	Not Supported	8.3.1
SFP-10G-24DWD80	Not Supported	8.3.1
SFP-10G-GIG-SR	Not Supported	8.3.1

Transceiver	OS99-CMM	OS99-XNI-U48
SFP-10G-GIG-LR	Not Supported	8.3.1
SFP-FC-SR	Not Supported	Not Supported
QSFP-40G-SR	8.3.1.R02	Not Supported
QSFP-40G-SR-BD	8.3.1.R02	Not Supported
QSFP-40G-LR	8.3.1.R02	Not Supported
QSFP-40G-C	8.3.1.R02	Not Supported
QSFP-4X10G-SR	8.3.1.R02	Not Supported
QSFP-4X10G-C	8.3.1.R02	Not Supported
QSFP-40G-AOC20M	8.3.1.R02	Not Supported

1. Supports 1G only.